



VBOX Manager User Guide



This page intentionally left blank

Contents

Introduction	4
Features	4
Standard inventory.....	4
Power	4
Operation.....	5
Log Screen options	6
File naming.....	6
Setup.....	7
Menu options.....	7
Graph Mode.....	7
VBOX	8
IMU-INS.....	8
ADAS	8
DUAL ANTENNA	9
CLEAR CARD	9
Specifications	9
Connections	10
Firmware updates	10
Contact Information	10

Introduction

The Racelogic VBOX Manager is a versatile control unit that has been designed to provide in depth control of the VB3i SL dual antenna setup, VB3i ADAS functions and IMU integration. The VBOX Manager can also be used to compliment VB3i, VBOXIII, and VB20SX/SL GPS data logging systems by providing an easy to use graphical interface for control of logging functions. Housed in a compact enclosure, the VBOX Manager is equipped with a clear graphical LCD display and rotary, push-button controller.

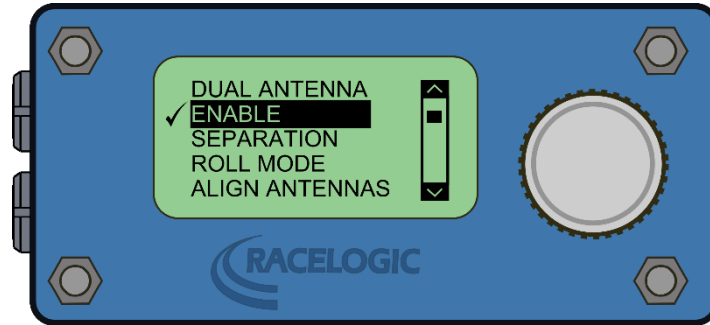

Features

- Provide Control of VB3i SL functions
- Provide Control of ADAS functions, (VB3i SL, VBOXIII and VBOX3i only)
- Enable IMU integration and set antenna offsets and gyro calibration.
- Control logging start/stop
- Delete unwanted files from the compact flash card
- Create VBOX data files with descriptive filenames in a logical directory
- Provide full control of VBOX settings, log rate, log mode, DGPS mode etc.
- Velocity graph mode
- Correctly Format CF cards using VBOXIII/VBOX3i

Standard inventory

Description	Qty	RL Part #
VBOX Manager	1	VBFMAN
5 Way Lemo – 5 Way Lemo - CAN Only	1	RLCAB005-C
VBOX Manager Manual	1	VBFMANMAN

Power

Caution

Please note that the operating voltage of the VBOX Manager must be between 6V and 28VDC. It is important therefore to ensure that the VBOX supply voltage is no higher than 28VDC when using the VBOX Manager.

Operation

The VBOX Manager uses a CAN Bus link to communicate with the VBOX. The connection should be made via the supplied RLVBCAB05C cable. This is normally connected between either of the two LEMO sockets on the VBOX Manager and the CAN connector on the VBOX. The VBOX connector marked CAN is the default bus for Racelogic module communication. However, if the VBOX Manager display constantly shows “NO CAN” then check the VBOX CAN setup in case the VBOX has been configured to use the “RS232” connector for Racelogic module communication.

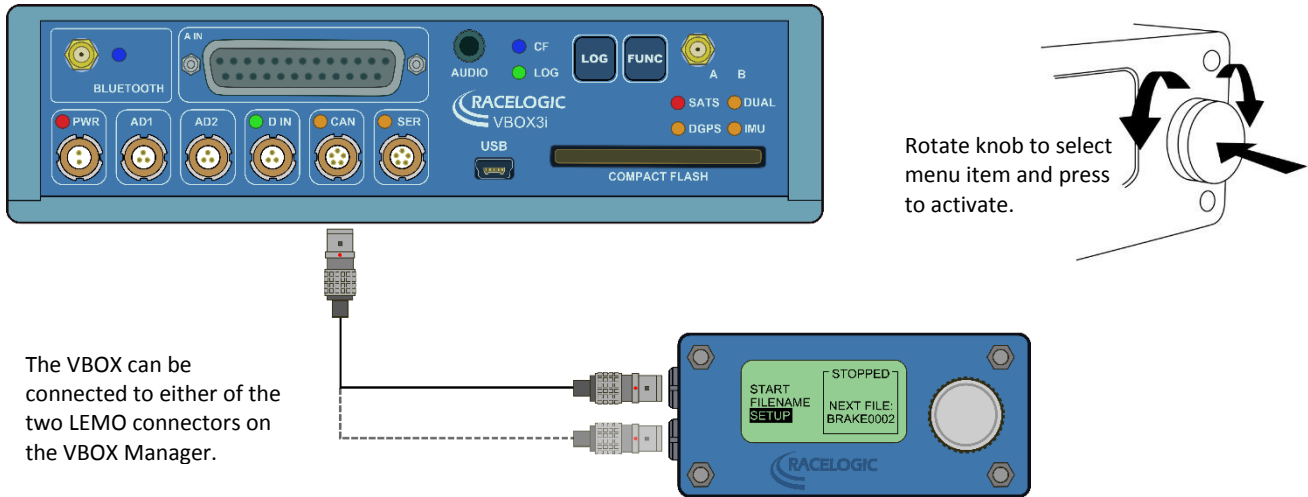

The VBOX Manager uses a rotary push-button knob to control VBOX functions and to navigate menu options. By rotating the knob when a menu is displayed, the user can select various menu items. To select a menu item, the user can press the knob in the centre.

Once connected to the VBOX, the VBOX Manager will display the current VBOX status for example:-

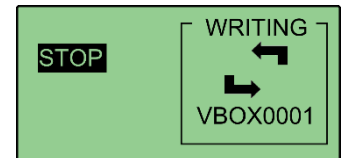

The example above shows that the VBOX is currently logging data to the compact flash card. While the VBOX is logging, the arrows will rotate. The highlighted text shows the action that will be performed when the knob is pressed. Therefore if the control knob is pressed in the example above, the VBOX will stop logging and show the following screen:

<p>KEEP Selecting this option will close current file on memory card and open new file. Note that the file number will be incremented.</p>		<p>LOG STATUS Indicates that logging is currently paused.</p>
<p>CONTINUE This option will cause the VBOX to continue logging to the current file.</p>		<p>VBOX0001 Filename of current log file.</p>
<p>DELETE This option will delete the currently open file and open a new file with the same file name.</p>		

Log Screen options

	START	Start logging. The NEXT FILE parameter shows the filename that will be created when logging begins.
	FILENAME	This option allows the user to create a new directory and filename for the VBOX data files. For example, if a filename BRAKE is entered, the VBOX will create a directory called BRAKE on the compact flash card and any subsequent data files will be named BRAKE001.VBO, BRAKE002.VBO, etc.
	SETUP	This option moves to the SETUP menu for configuration of the VBOX Manager.
	STOP	If the button is pressed in this display, the VBOX will stop logging and the display will show the KEEP, CONTINUE & DELETE menu options.
	ARMED	If the START option is selected when the VB3i SL has log mode set to 'log when moving', the screen will show ARMED. This indicates that the recording media has been detected, and the unit is waiting for starting conditions to be met before logging commences. The upcoming filename will be displayed under the cross-hair image. If no recording media is detected, there will be a 'No Card!' message.
	KEEP	KEEP File. This option will close the current data file and open a new file with the filename number incremented by one.
	CONTINUE	This option will start logging again to the currently open file.
	DELETE	Delete the currently open file and open a new file with the same file name. When DELETE is selected the display will ask the user to confirm before deleting the file to prevent accidental erasure.

File naming

Click on the "FILENAME" menu option to enter a screen which allows the creation and selection of logical directories and file names. For example, the following directories could be made on the card: ACCEL, BRAKE, and COAST.

In the VBOX Manager, it is then possible to select any of these directories as the locations of data files logged by the VBOX. For example, selecting the 'ACCEL' directory will create the files 'ACCEL001.VBO', then 'ACCEL002.VBO', then 'ACCEL003.VBO', and so on, each within the ACCEL directory.

NOTE: The following words cannot be used as file names due to a clash with processor commands

CON, PRN, LPT1, COM1.

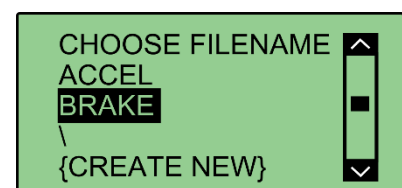

Setup

Menu options

	GRAPH	The GRAPH option in the setup menu is used to display the graph mode options
	VBOX	VBOX settings like Log mode, Log rate, DGPS mode etc.
	IMU-INS	Enable IMU integration and set antenna / gyro offsets.
	ADAS	ADAS setup and configure functions.
	DUAL ANTENNA	Enable/disable the Dual antenna mode (When connected to a VB3i SL)
	CLEAR CARD	Clear card options, Delete All and Format
	FLIP SCREEN	Selecting The FLIP SCREEN option will rotate the VBOX Manager screen by 180° to allow left-hand operation.
	EXIT	EXIT. Return to operating mode.

Graph Mode

In addition to the text mode, the VBOX Manager can also operate in a graphical display mode where a velocity trace is shown to allow the user to verify the correct speed profile. Graph mode is selected by clicking on the ENABLE option in the GRAPH SETUP screen. When selected, a tick will be shown next to the ENABLE option. Graph setup options are shown below.

	ENABLE	Enable / Disable Graphical mode.
	SPEED UNITS	Select Mile per hour MPH or Kilometres per hour KMH .
	SPEED RANGE	Select the speed range for the graph display. Options for the speed range are 0-10, 0-50, 0-100 & 0-200.
	TIMESCALE	The timescale setting defines the time base for the graph display. Settings available are 6seconds, 12seconds, 24seconds and 120 seconds. For example, if the 6 second option is selected, the total velocity graph from left to right will represent 6 seconds of data.
	BACK	Return to main setup menu

Graph mode screen example

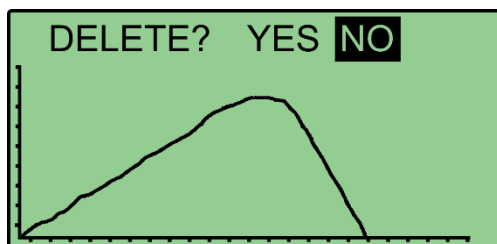

VBOX

	LOG RATE	Adjust VBOX logging rate. Options available are 100Hz, 50Hz, 20Hz, 5Hz, and 1Hz dependant on VBOX type.
	LOG MODE	Select VBOX log mode. Options available are LOG WHEN MOVING and LOG ALL TIME.
	DYNAMICS	Display VBOX DYNAMIC mode selection menu. Allows selection of Low, Medium and High dynamics.
	GPS FILTER	GPS Filter can only be enabled when IMU integration disabled.
	DGPS MODE	Select one of the available DGPS modes in which you want the VBOX to operate.
	DGPS RS232 RATE	Set the DGPS RS232 Rate.
	COLDSTART	Select to perform a GPS cold start.
	ELEVATION MASK	Set elevation mask for GPS engine to ignore satellites below selected mask angle.
	BACK	Return to Setup menu.

IMU-INS

See the VB3i / IMU application manual for full instruction on the use of the available functions.

	ENABLE	Enable / Disable IMU integration mode (IMU03 / IMU04 must be connected to VB3i).
	ANTENNA OFFSETS	Set offsets for distances between IMU and Antenna.
	GYRO OFFSETS	Reset / calibrate IMU internal gyro offsets.
	BACK	Return to Setup menu.

ADAS

See the ADAS application manual for full instruction on using this VBOXIII/3i facility.

	OFF	Returns the VBOX to a non ADAS mode ready for all normal VBOXIII/3i functionality.
	MULTI. TARGET	Select this menu option to set the VBOX into either Subject, Target 1 or Target 2 mode, for use in multi target vehicle separation testing.
	SINGLE TARGET	Select this menu option to set the VBOX into either Subject, Target mode, for use in single target vehicle separation testing.
	STATIC POINT	Static Point mode allows vehicle separation data to be calculated from a nominated point, also set from within this menu.
	LANE DEP	Lane Departure causes the VBOXIII/3i to allow Lane departure channels to be calculated with respect to a straight line defined within this menu or a curved lane loaded from within this menu
	BACK	Return to Setup Menu.

DUAL ANTENNA

See the VB3i SL application manual for full instruction on the use of the available functions.

	ENABLE	Set the VB3i SL to be in dual antenna mode (ENABLE is ticked) or single antenna mode (ENABLED not ticked).
	SEPARATION	Sets the separation distance between the two antennas.
	ROLL MODE	Sets roll mode on/off. When ticked a 90° heading offset is configured, for use when antennas are positioned in a roll configuration (across the width of the car).
	ALIGN ANTENNAS	Within this sub menu the antennas can be auto aligned to ensure the heading is aligned to the vehicle body. Automatic calculation must be carried out while moving in a straight line, at a constant steady speed. Alignment offset can also be cleared.
	LEVEL ANTENNAS	Within this sub menu the antennas can be auto levelled to provide a zero reference for pitch or roll measurements.
	SLIP TRANSLATION	Enter x and y distances to translate the slip angle measurement to up to five different positions on the vehicle.
	BACK	Return to VBOX Menu.

CLEAR CARD

	DELETE ALL	The DELETE ALL option is used to delete all of the files on the compact flash card.
	FORMAT	The FORMAT option will instruct the VBOX to FORMAT the current compact flash card. It is important to note that ALL previous data on the card will be lost.
	BACK	Return to Setup Menu.

Specifications

Parameter	Conditions
Data link	VBOX CAN Bus
Size	100mm x 50mm x 25mm / 3.9" x 1.9" x .98"
Weight	100g / 3.5oz
LCD Display	128 x 64 pixel Green LED backlight
Operating temperature	-20 to 50 °C
User input	Rotary push-button knob
Input Voltage Range	6 to 28VDC
Max Current	Approx 120mA @ 12V

Connections

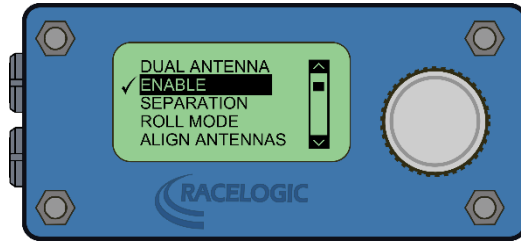

Front view of unit

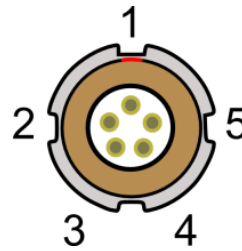

5 PIN LEMO Socket

Top LEMO

Pin	I/O	Function	
1	O	TxD, Serial Data Transmit	Firmware upgrade
2	I	RxD, Serial Data Receive	Firmware upgrade
3	I/O	CAN High	Linked to Bottom LEMO CAN High
4	I/O	CAN Low	Linked to Bottom LEMO CAN Low
5	O	+V Power	
Chassis		Ground	Chassis

Bottom LEMO

Pin	I/O	Function	Note
1	O	-	
2	I	-	
3	I/O	CAN High	Linked to Top LEMO CAN High
4	I/O	CAN Low	Linked to Top LEMO CAN Low
5	O	+V Power	
Chassis		Ground	Chassis

Firmware updates

From time to time, Racelogic may release new versions of firmware to improve the operation of the VBOX Manager. It is advisable to check the Racelogic web site for updates periodically to be sure that you have the latest firmware version.

To upgrade the VBOX Manager, download the latest upgrade file from the Racelogic web site. The file will have a '.RUF' file extension. The VBOX Manager should be powered by connecting a CAB05C cable between the VBOX CAN connector and the bottom LEMO connector on the VBOX Manager. Using the CAB01 serial cable, connect the top LEMO connector on the VBOX Manager to the serial port of the PC. Double click the upgrade file and follow the on-screen instructions. If you have any questions about the upgrade procedure, please do not hesitate to contact Racelogic.

Contact Information

Racelogic Ltd
 Unit 10
 Swan Business Centre
 Osier Way
 Buckingham
 MK18 1TB
 England

Tel: +44 (0) 1280 823803 Fax: +44 (0) 1280 823595 Email: support@racelogic.co.uk Web: www.racelogic.co.uk